

Easily **A**pplicable **G**raphical **L**ayout **E**ditor **EAGLE**

Schematic, Spice Simulator and Layout Editor

Instituto Tecnológico de Morelia
Maestría en Ciencias en Ingeniería Electrónica

June 17, 2018

- 1 Introduction
 - What is EAGLE?
 - System Requirements
 - License
- 2 Schematic editor
 - Work space
- 3 Layout editor
 - Work space
 - Time to work

EAGLE is a software to design schematics and **PCBs** (Printed Circuit Boards). Its popularity around the world became for the use in **DiY** (Do it Yourself) electronic projects; because have a Freeware license and a large number of component libraries around the network.

- The **Schematic Editor** allows to draw diagrams for electronic systems.
- The **Layout Editor**, which allows to design **PCBs**.

System Requirements for Autodesk EAGLE

Operative System	Requirements
Windows	Microsoft® Windows® 7 or newer is required. EAGLE 64-bit requires a 64-bit operating system.
Linux	Linux® based on kernel 2.6 for Intel computers, X11 with a minimum color depth of 8 bpp, the following runtime libraries: libssl.so.1.0.0, libcrypto.so.1.0.0, and CUPS for printing.
Mac	Apple® Mac OS® X version 10.10 or above for Intel computers.
All operating Systems	A minimum graphics resolution of 1024x768 pixels and preferably a 3-button wheel mouse .

License



Figura 2: <https://www.autodesk.com/education/free-software/eagle>

Get Education Benefits

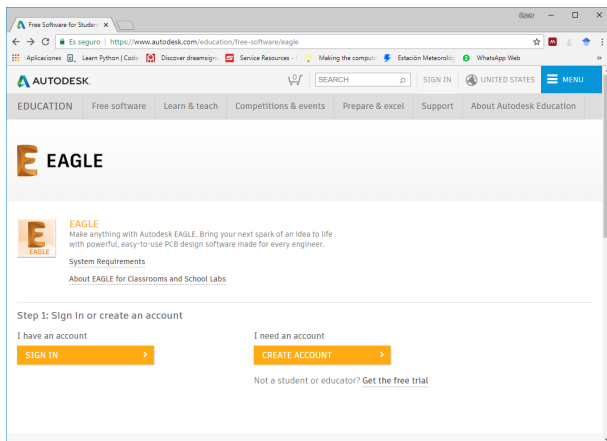

Country, Territory, or Region of educational institution

Country, Territory, or Region ▼

Educational role

[WHAT'S THIS ?](#)

Educational role ▼

NEXT

ALREADY HAVE AN ACCOUNT? [SIGN IN](#)

Your account for everything Autodesk

[LEARN MORE](#)

Get Education Benefits



Country, Territory, or Region of educational institution

Mexico

Educational role

[WHAT'S THIS ?](#)

Student

Date of Birth

September

16

1991

NEXT

ALREADY HAVE AN ACCOUNT? [SIGN IN](#)

Your account for everything Autodesk

[LEARN MORE](#)

Create account



First name

Oscar

Last name

Lobato

Email

relobato15@hotmail.com



Confirm email

relobato15@hotmail.com



Password

|

- At least 1 letter
- At least 1 number
- Minimum of 8 characters
- At least 3 unique characters

I agree to the [Autodesk Terms of Use](#) and to the use of my personal information in accordance with the [Privacy Statement](#) (including cross-border transfers as described in the statement).

CREATE ACCOUNT

ALREADY HAVE AN ACCOUNT? [SIGN IN](#)



Figura 6: <https://www.autodesk.com/education/free-software/eagle>

Just one more step

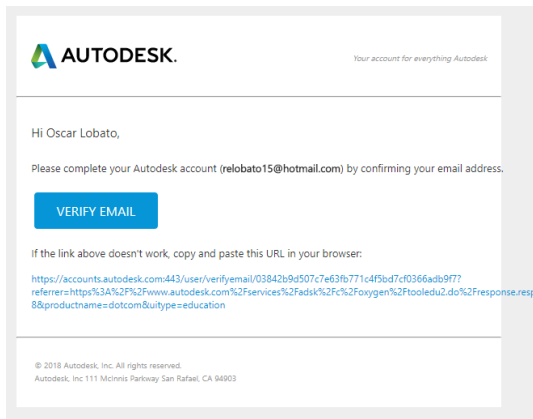

Tell us about your educational institution and how you plan to use your free software.

Name of educational institution

Instituto Tecnológico de Morelia

Area of study

- Architecture, Engineering & Construction
- Media & Entertainment
- Product Design & Manufacturing
- Others

Enrolled from

January ▼

2017 ▼

Graduate in

March ▼

2019 ▼

NEXT

Panel Control

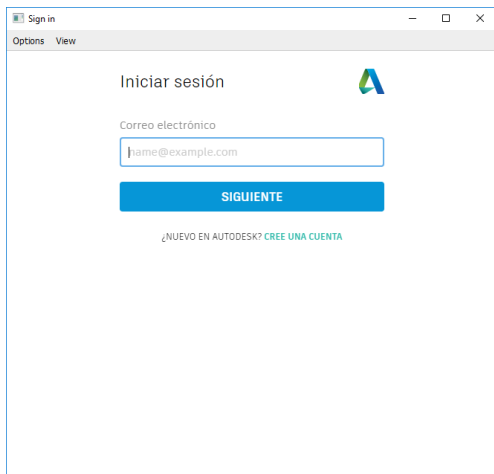

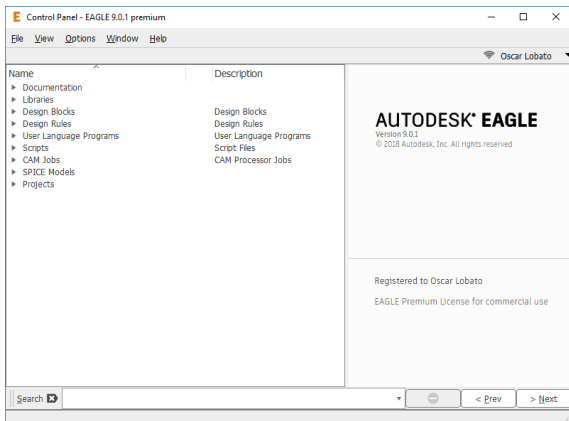



Figura 8: Close project



Figura 9: Open project

Create new Schematic project

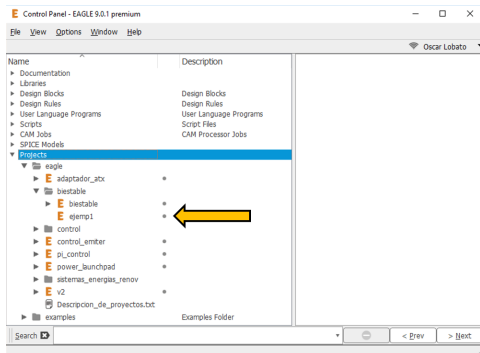

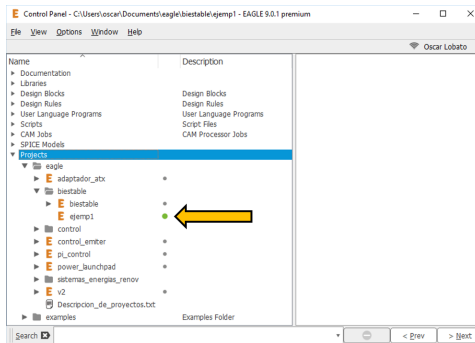
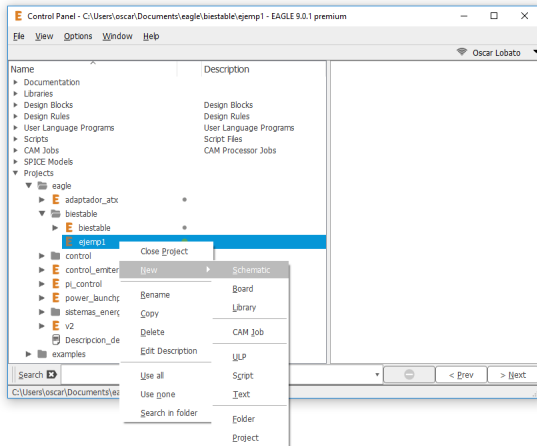
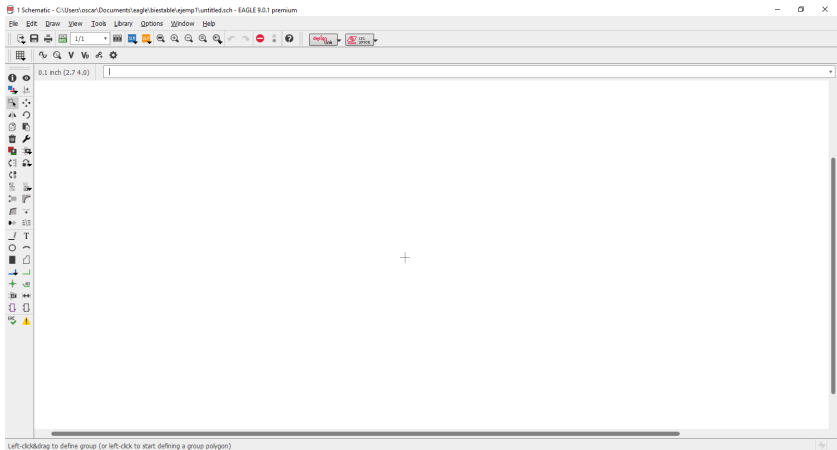

Create new Layout project

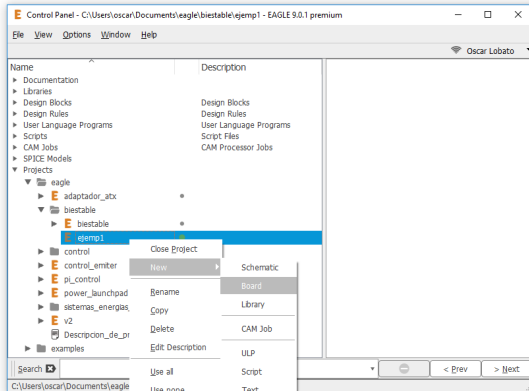

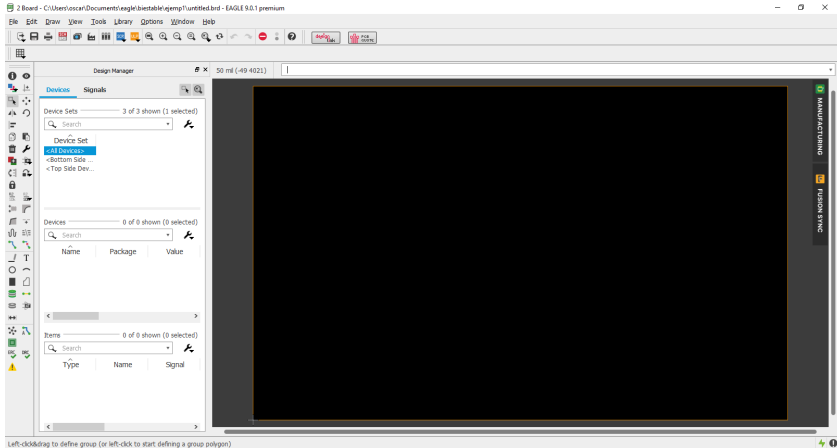

Your project

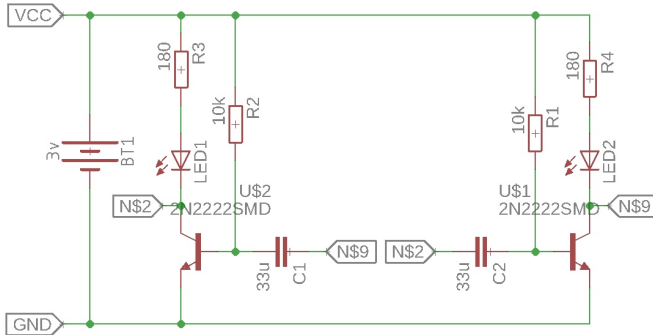

Packages

For this project use the next packages:

- R_x - 1206
- C_x - 1206
- L_x - 1206
- Q_x - SOT23
- B_1 - 20mm

